

№1,20 ბოცა

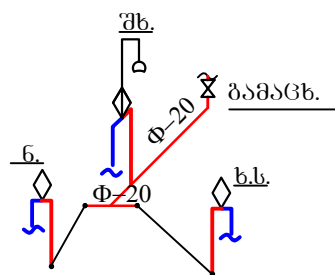

№2,21 ბოცა

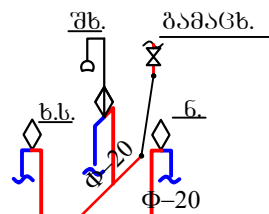

№5,24 ბოცა

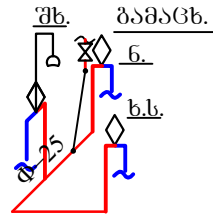

№6,25,39 ბოცა

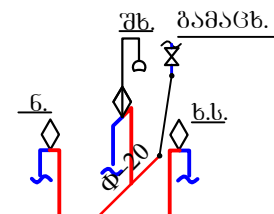

№9,28,42 ბოცა

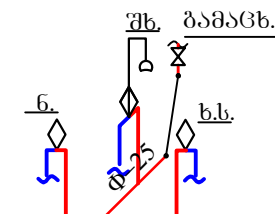

№3,22 ბოცა

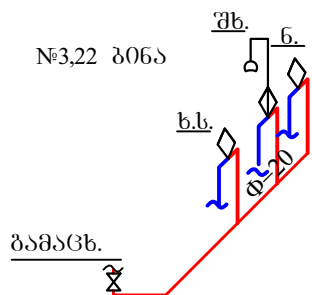

№4,23 ბოცა

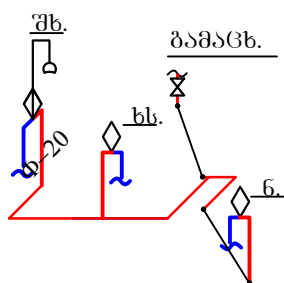

№12,31,45 ბოცა

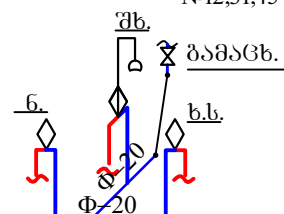

№16,35,49 ბოცა

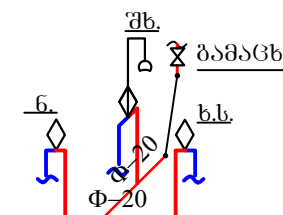

№8,27,41 ბოცა

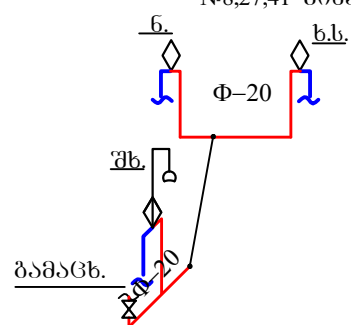

№11,30,44 ბოცა

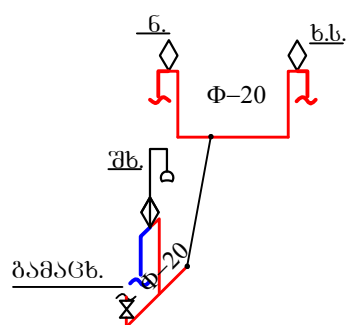

№15,34,48 ბოცა

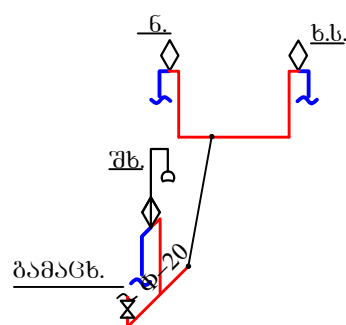

№17,36,50 ბოცა

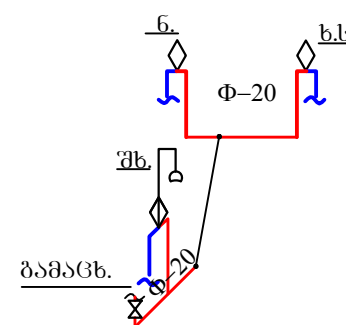

№14,33,47 ბოცა

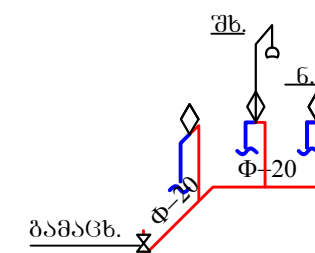

№7,26,40 ბოცა

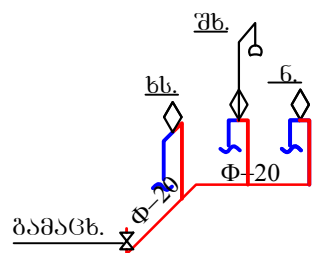

№13,32,45 ბოცა

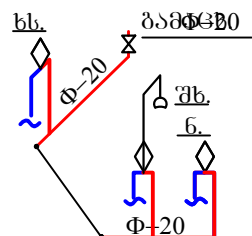

№18,37,51 ბოცა

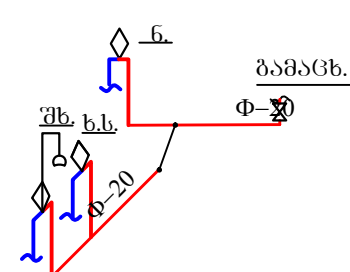

№10,29,43 ბოცა

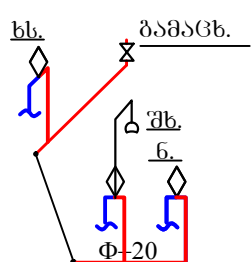

№19,38,52 ბოცა

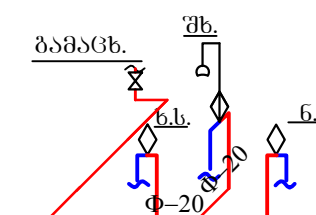

თანამდებობა	გვარი	თარიღი	ხელმოწერა	მ. ხაშური, სააკაძის ქუჩა №2 მდებარე (ყოფილი სანავაღმყოფო) შენობის რეკონსტრუქციის საცხოვრებელ კორპუსად	სტადია	ფურცელი	ფურცლები
დირექტორი	ბ. ლომუაძე				შპს-ი	№3 -9	A3
არქიტექტორი	მ. ოსუნიძე				მასშტაბი		
ლაშქარაძე	ლ. კაციაშვილი				1 : 150		
				გლოკი ,,ბ,, ტიპური საბინის ბინების ცხელი წყლის სისტემა			„ბ. ლ. ლომუაძე“