

დაამუშავა					
გეგმავდა					
კონსტრუქტორი					
შემამუშავებელი					
დირექტორი					
26-ბ-12					
ღვინაძის საინჟინერო ბიურო					
ქულის არხი		სტადია	ფურც.	ფურცლები	
გზის კრილი		მ.პ.	1	1	

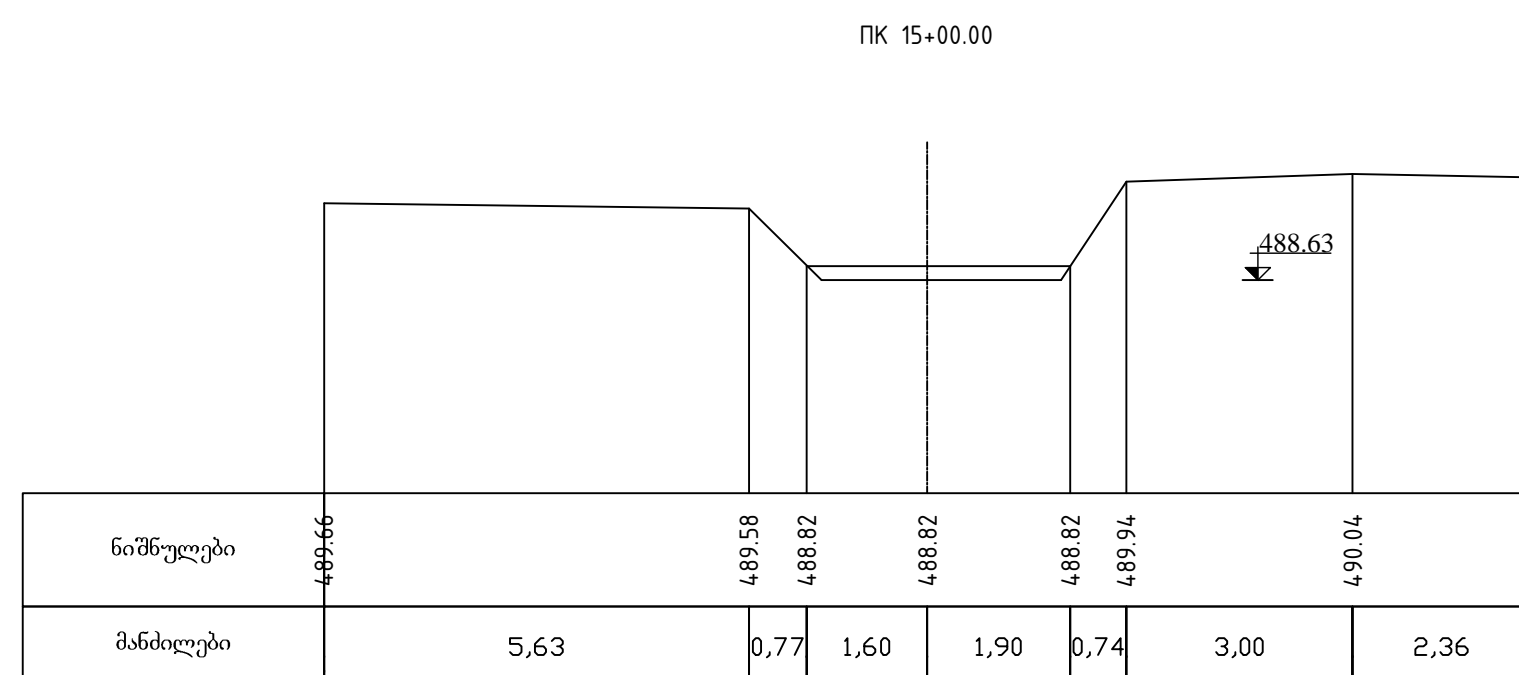

დაამუშავა				26-ბ-13		
გამოამუშავა						
შეამუშავა						
შეამუშავა				ღვინაშვილი სარგებლობის სისტემა		
შეამუშავა				კულარის არხი		
შეამუშავა				სტადია	ფურც.	ფურცლები
შეამუშავა				მ.პ.	1	3
შეამუშავა				განვივი კურსი		

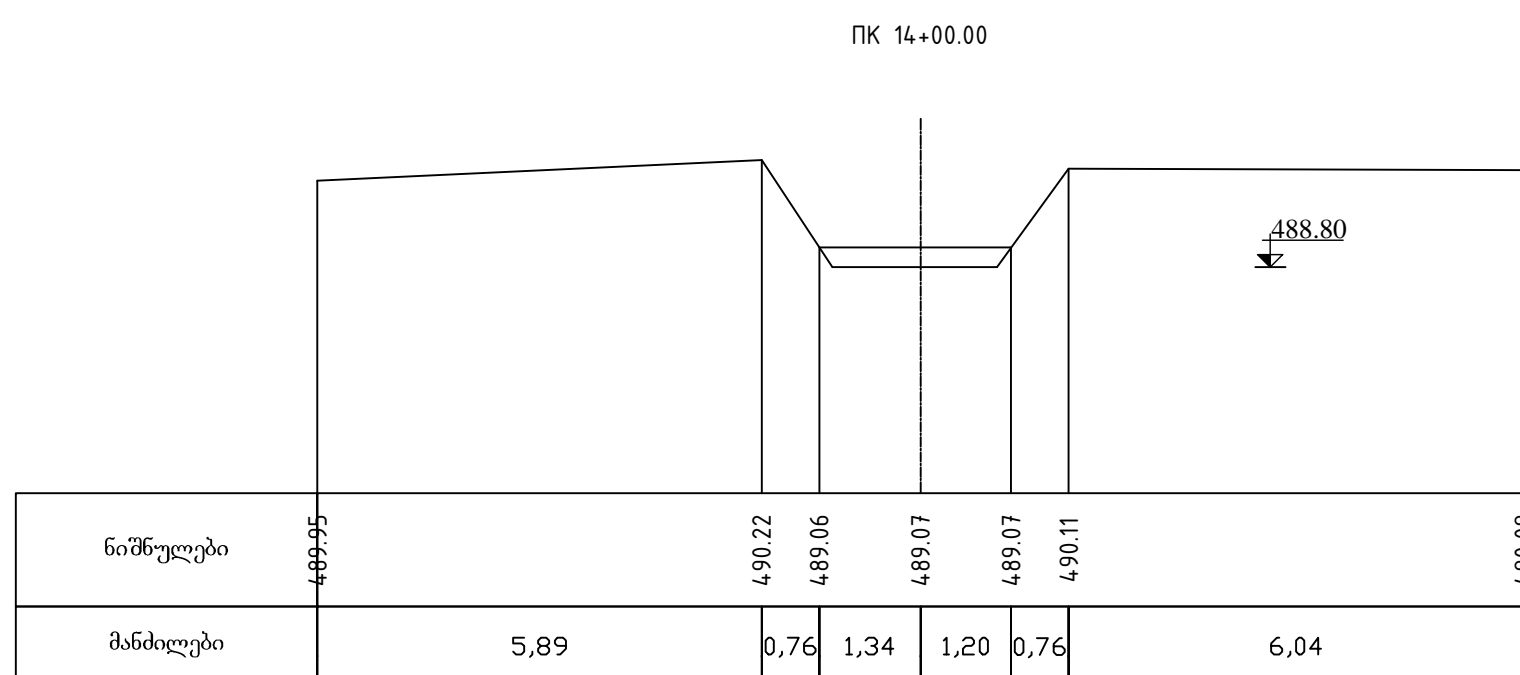
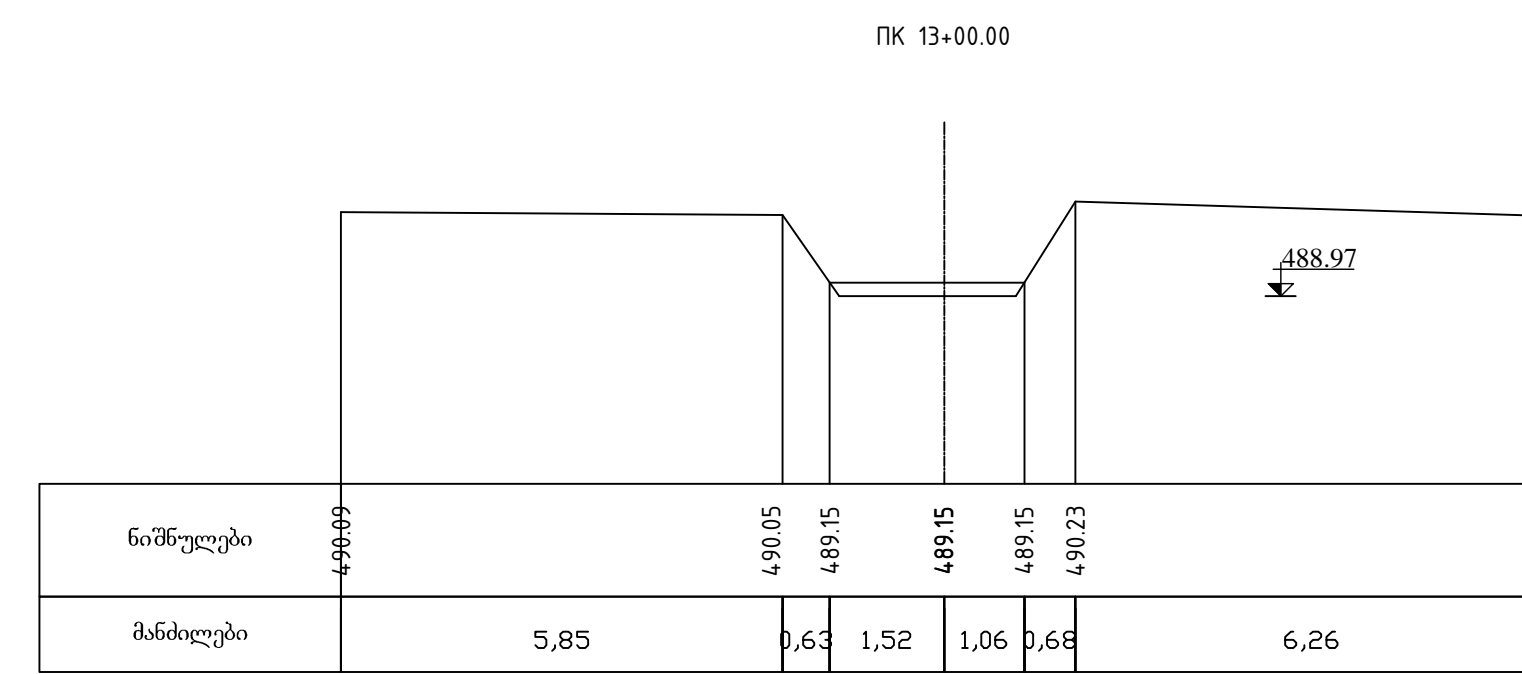
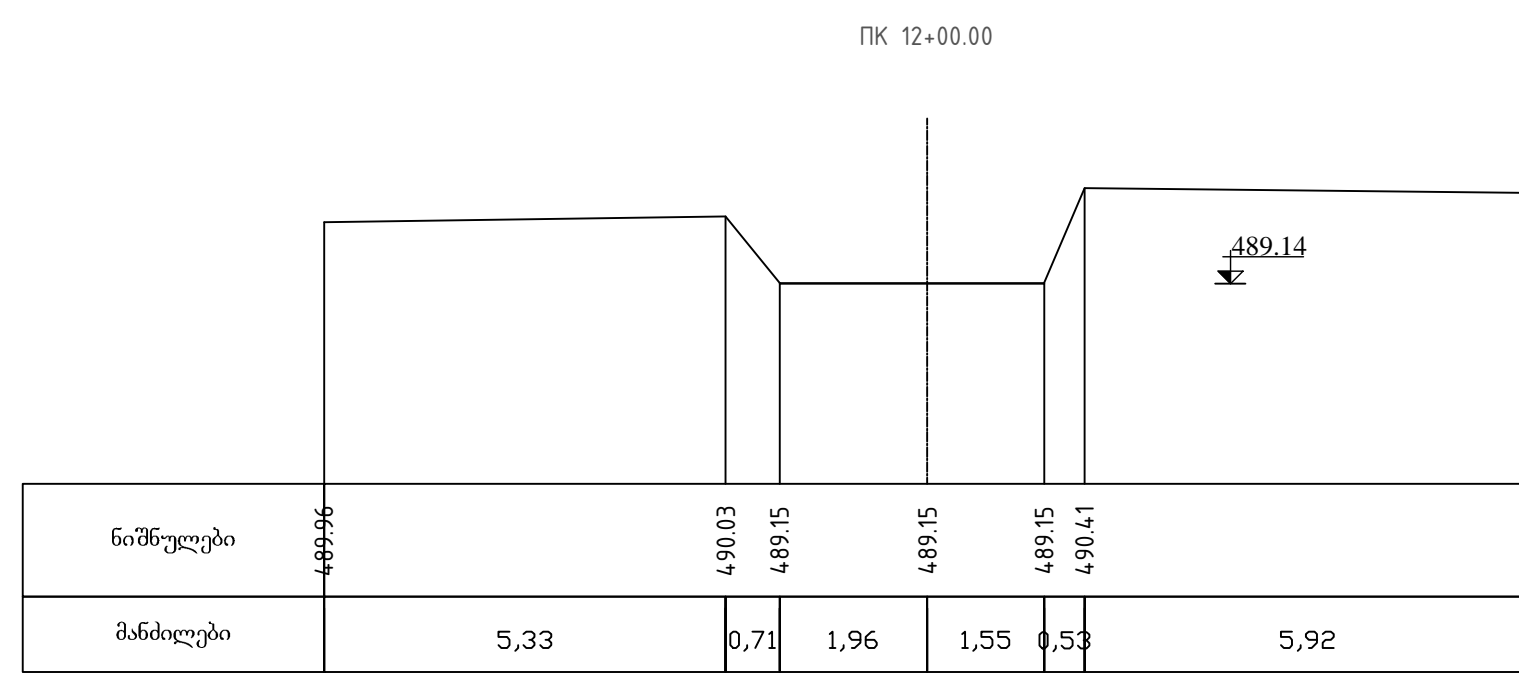
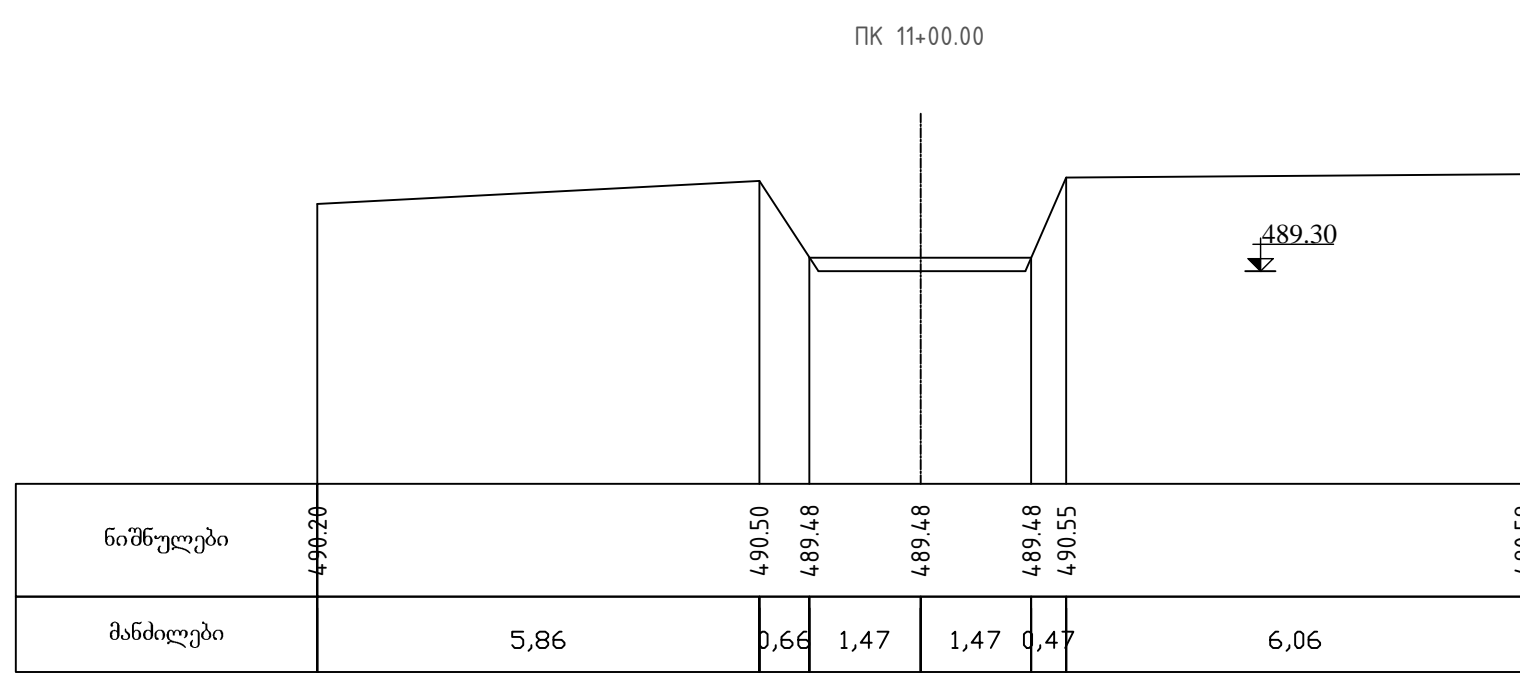
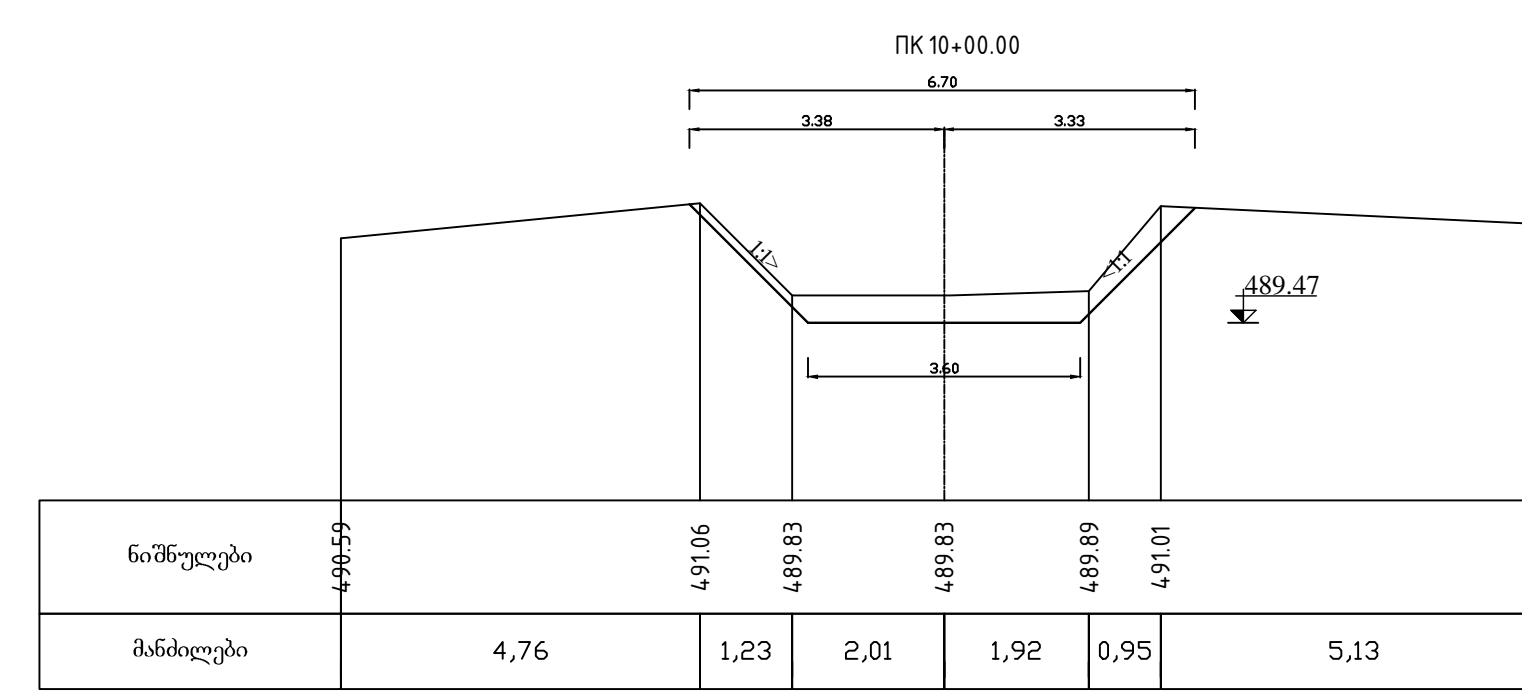
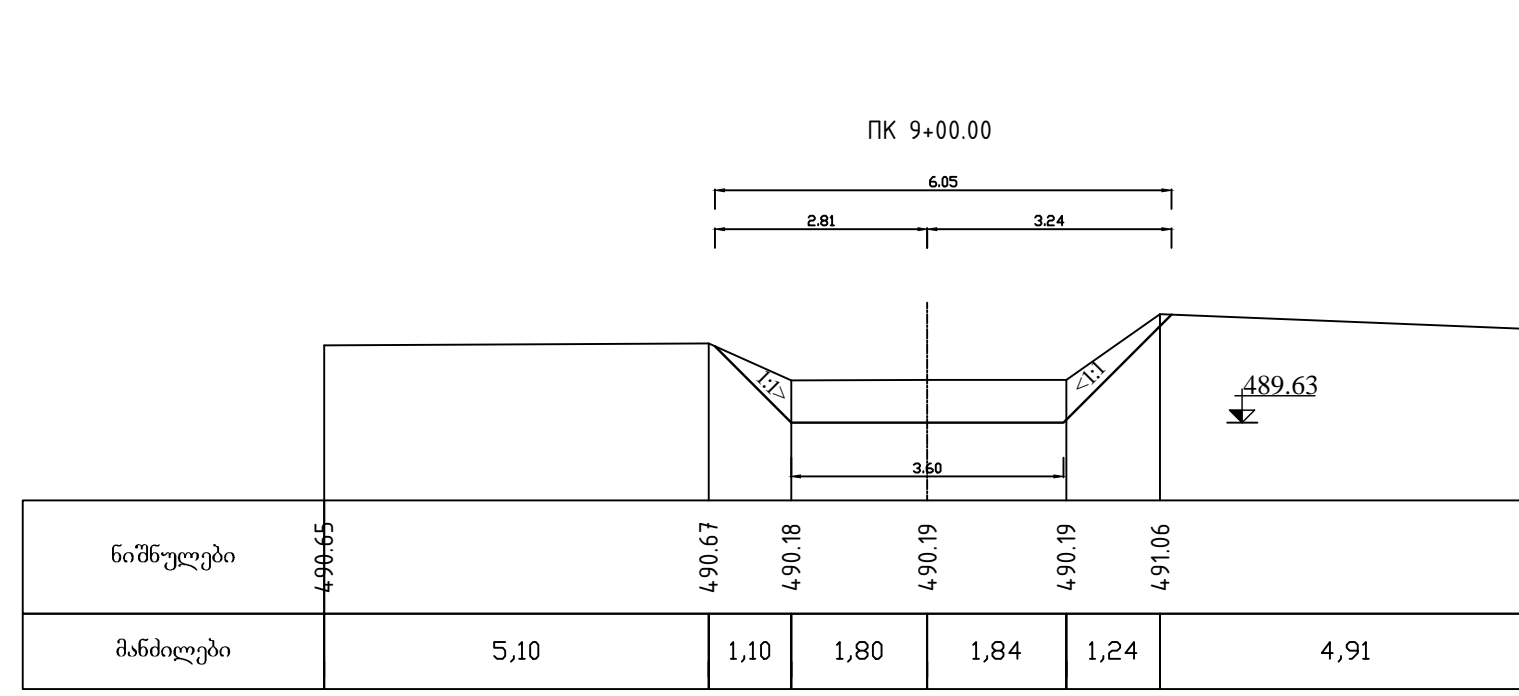
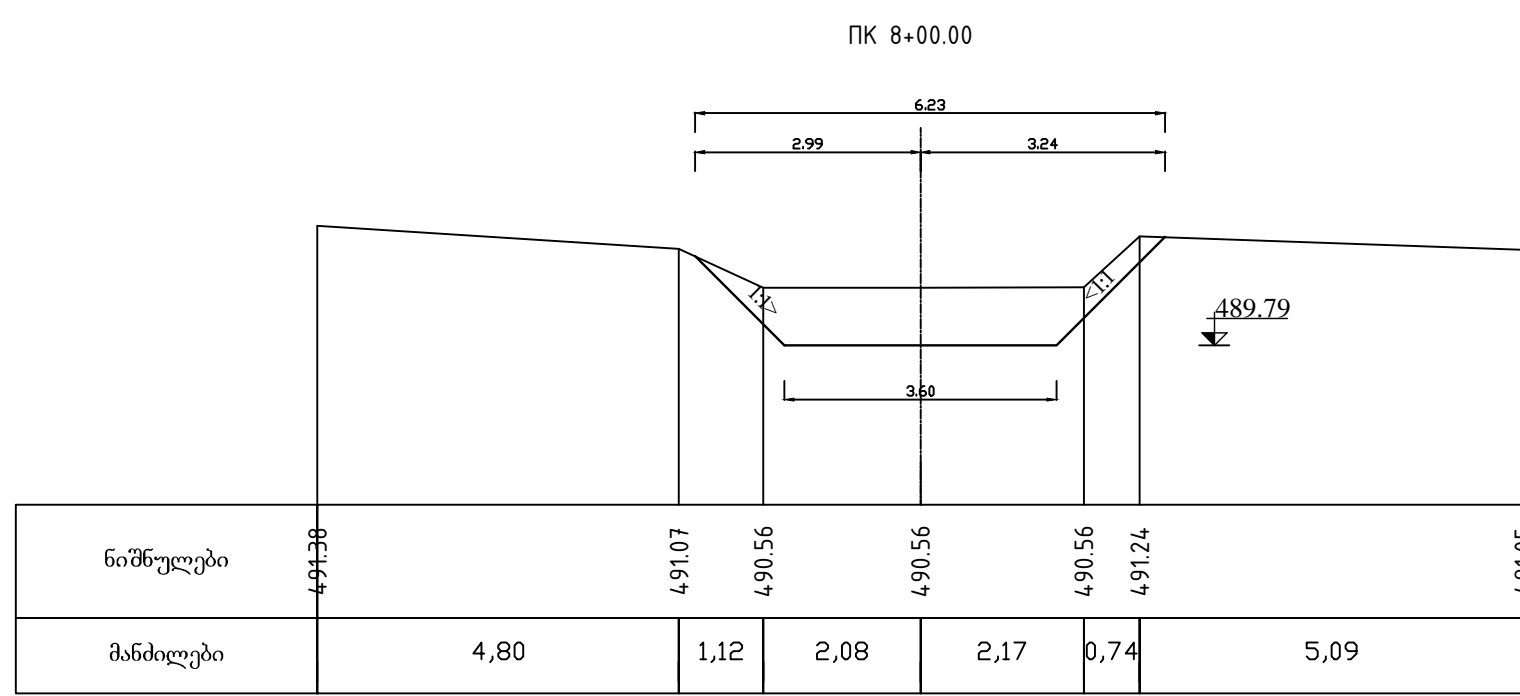
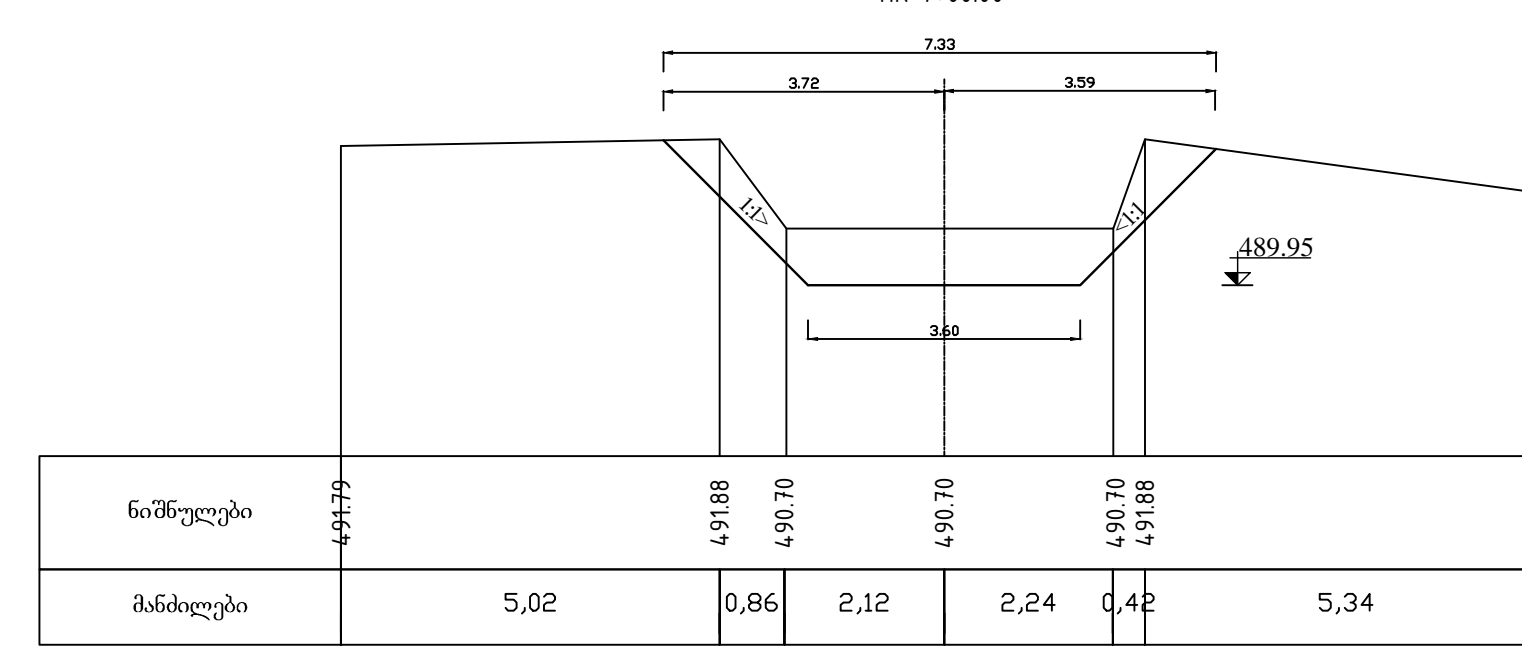
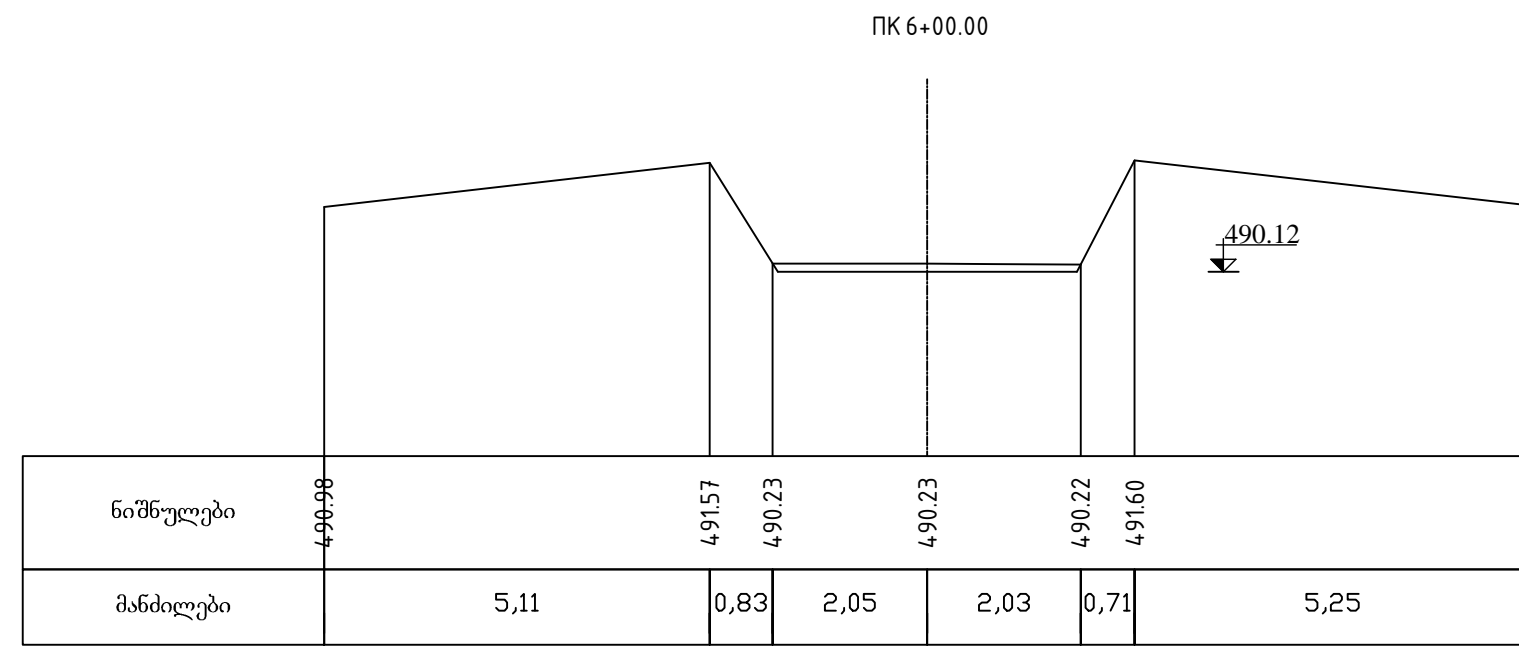
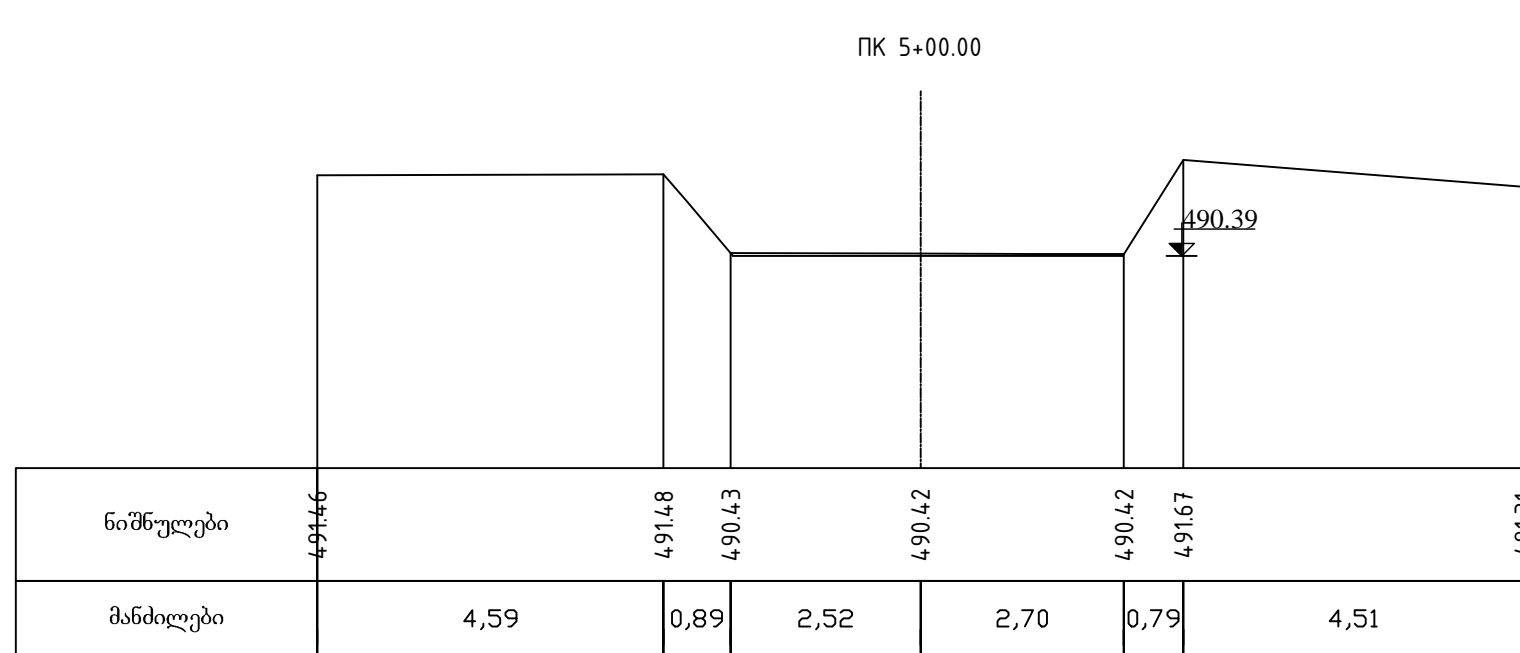
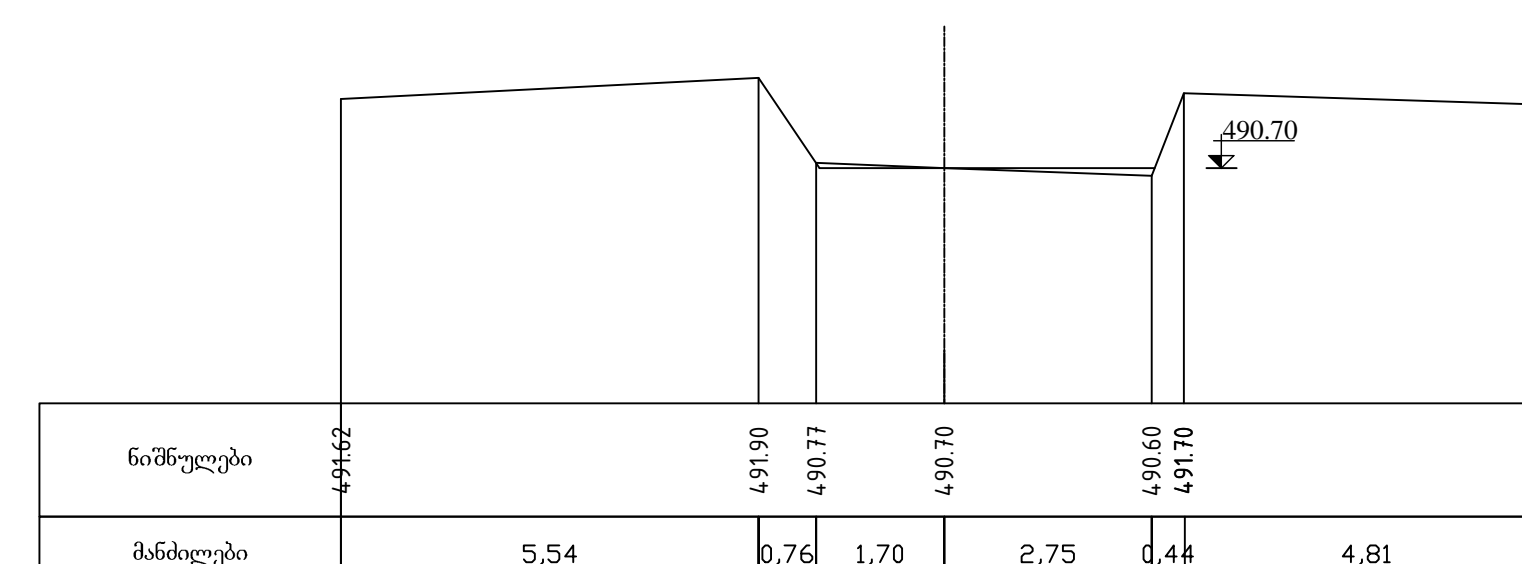
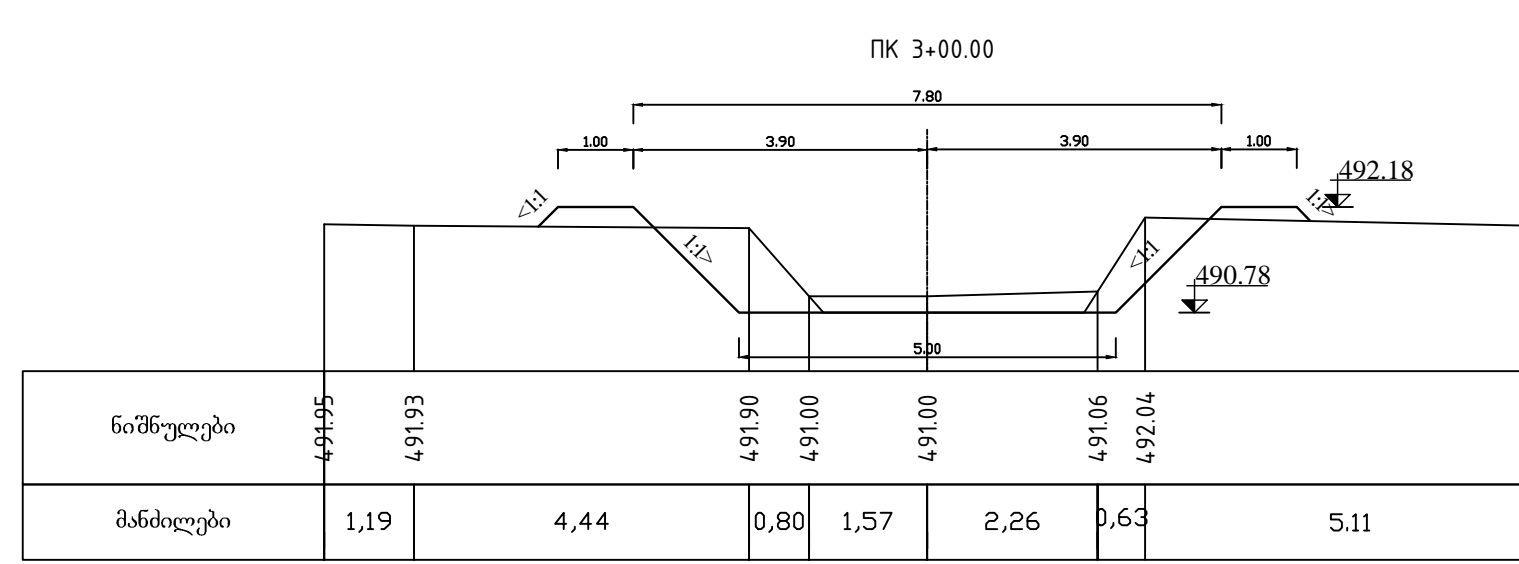
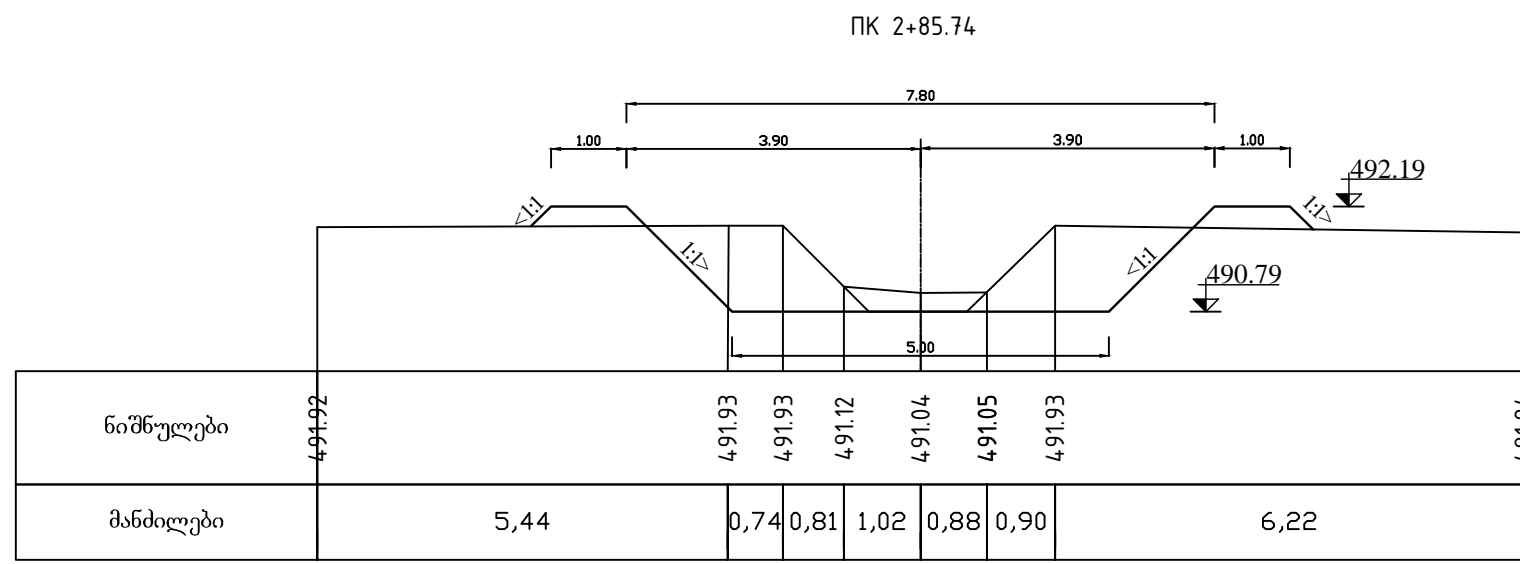
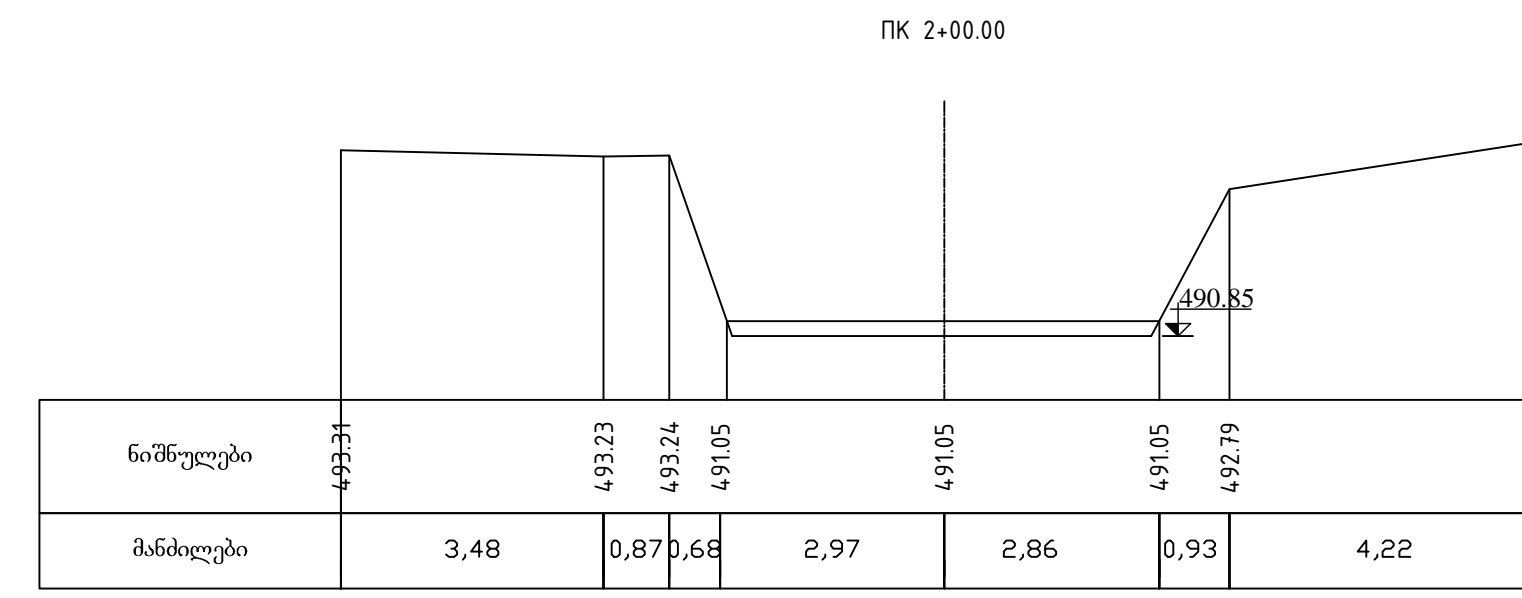
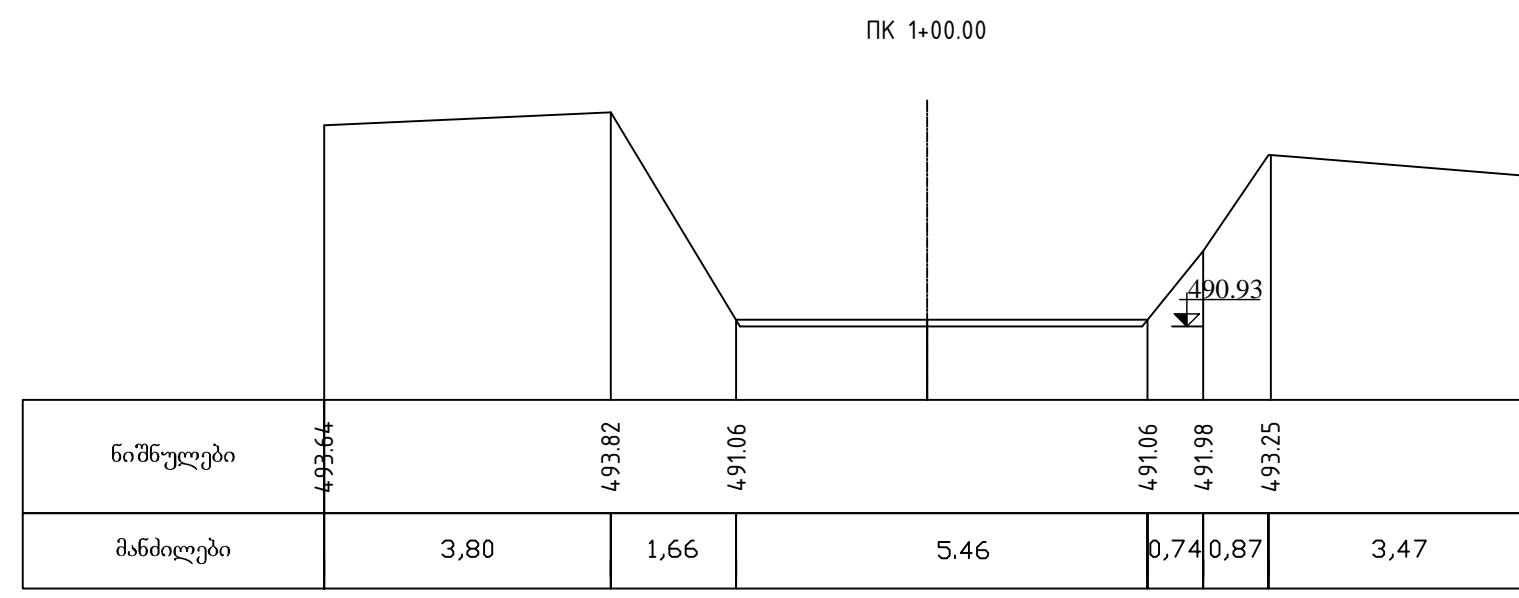
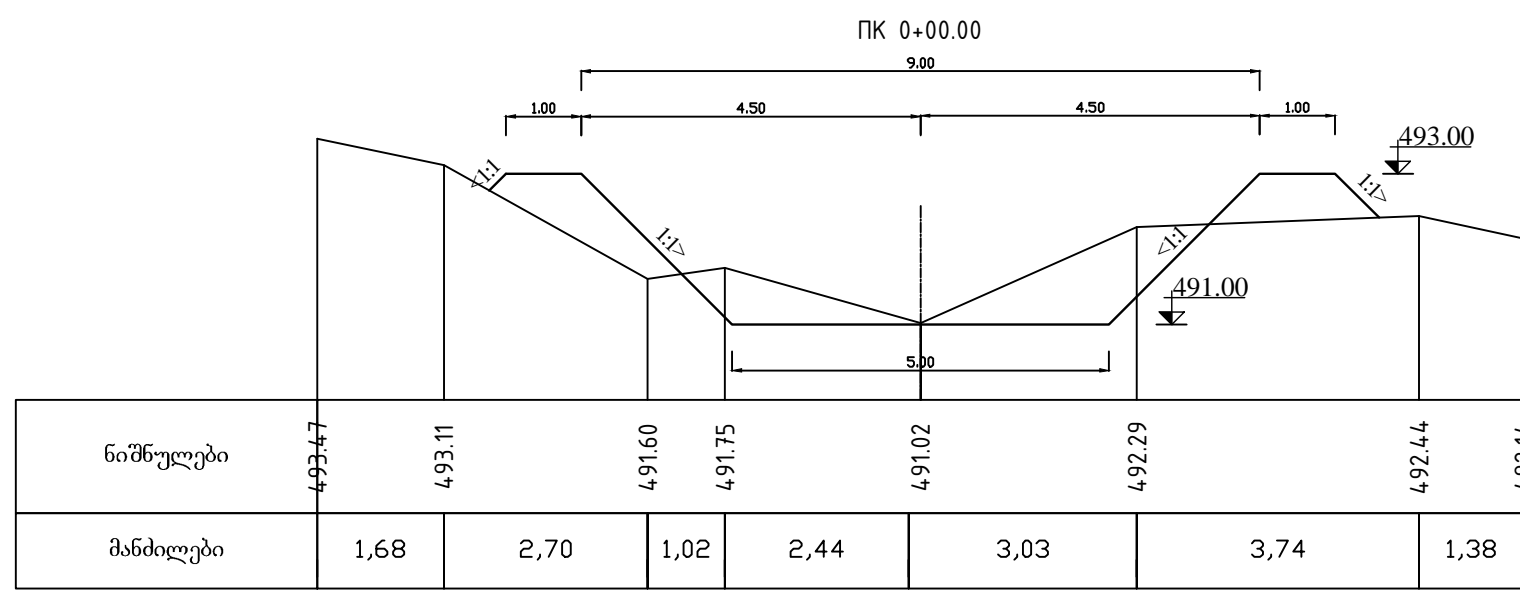
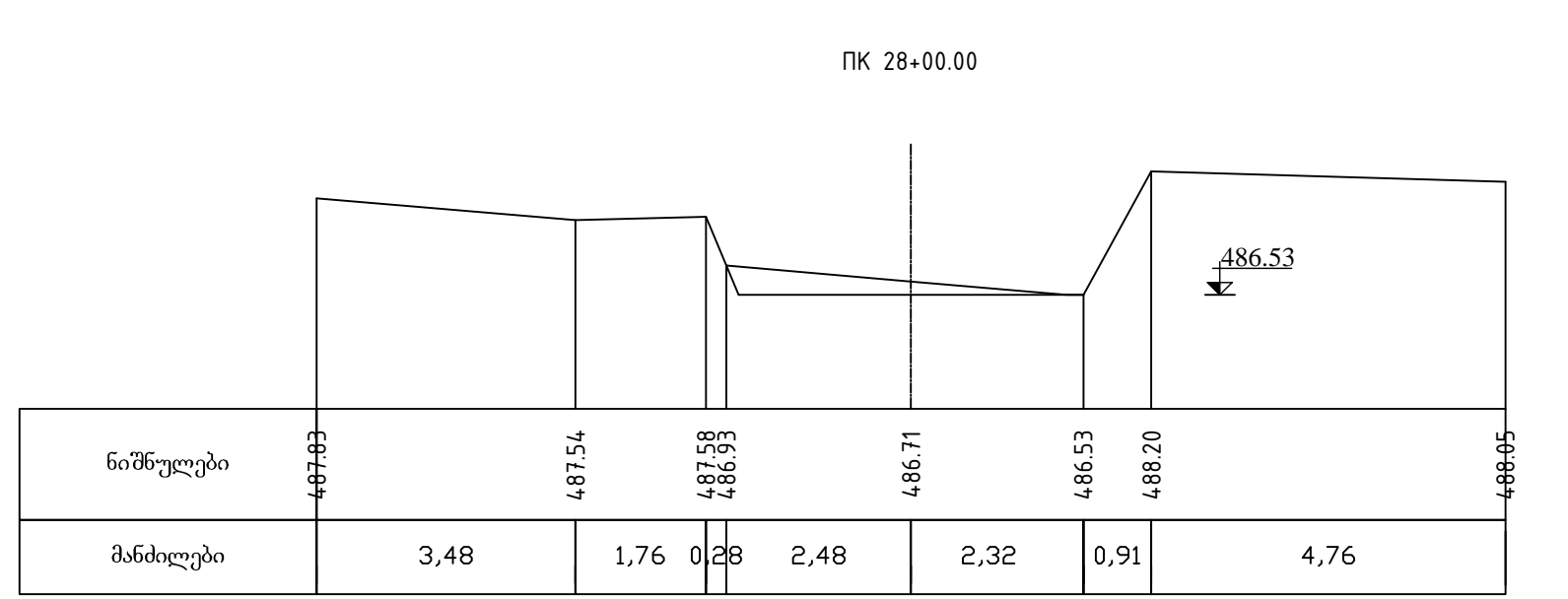
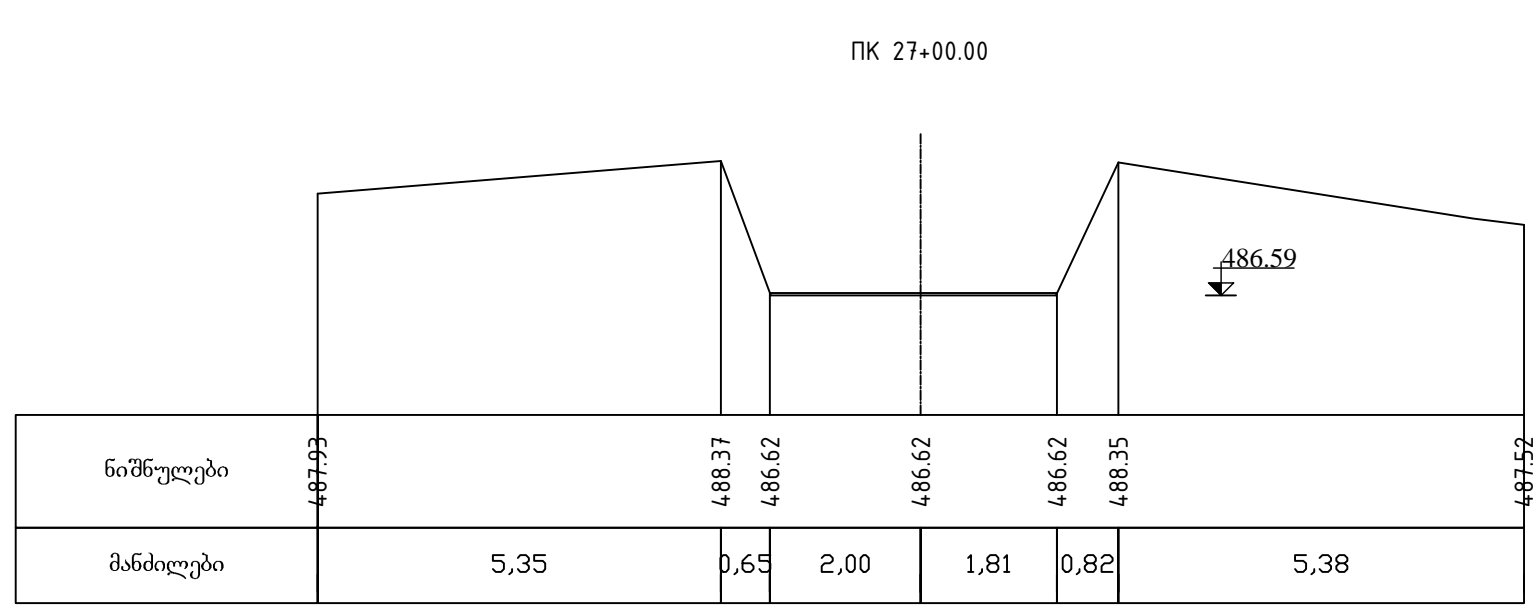
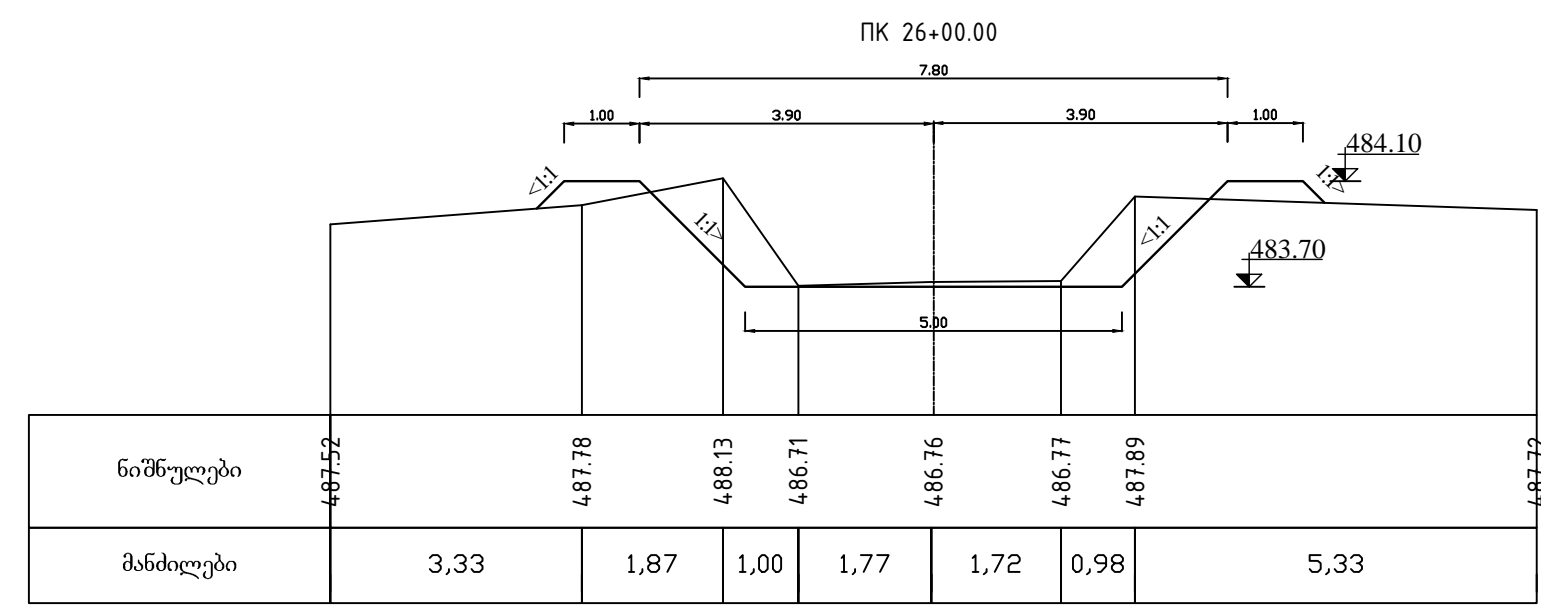
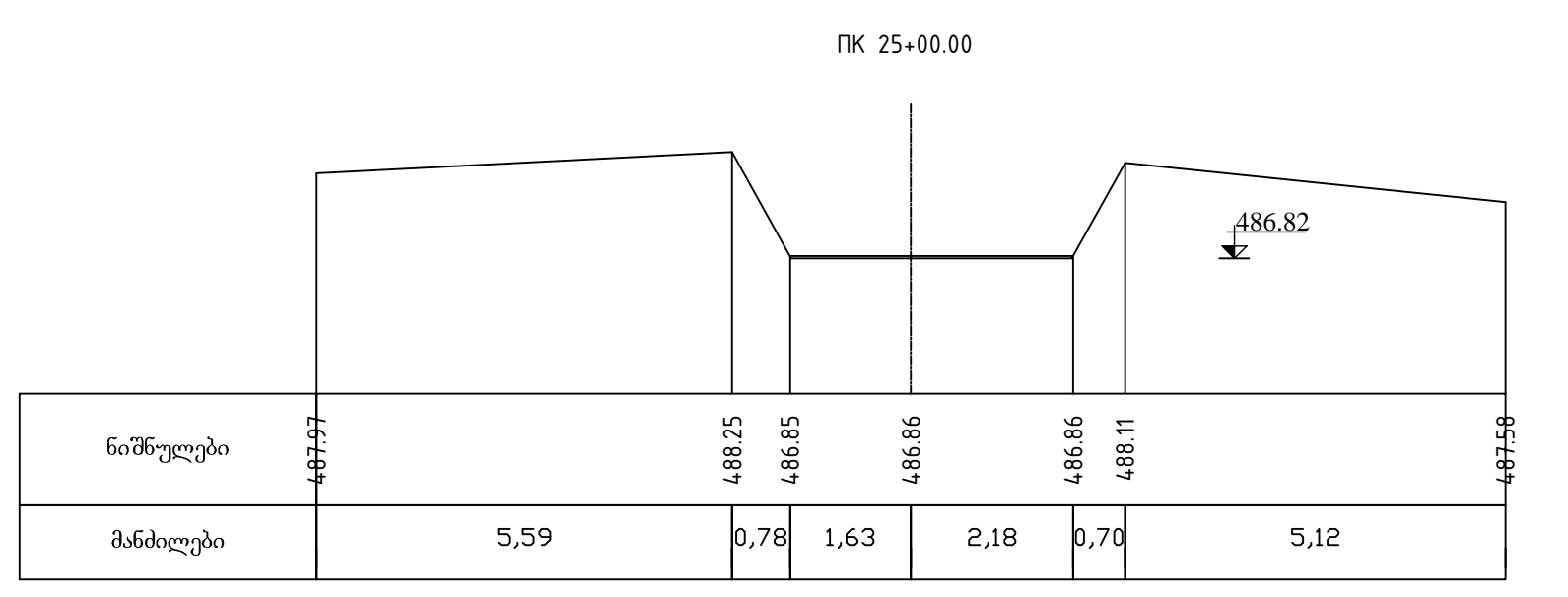
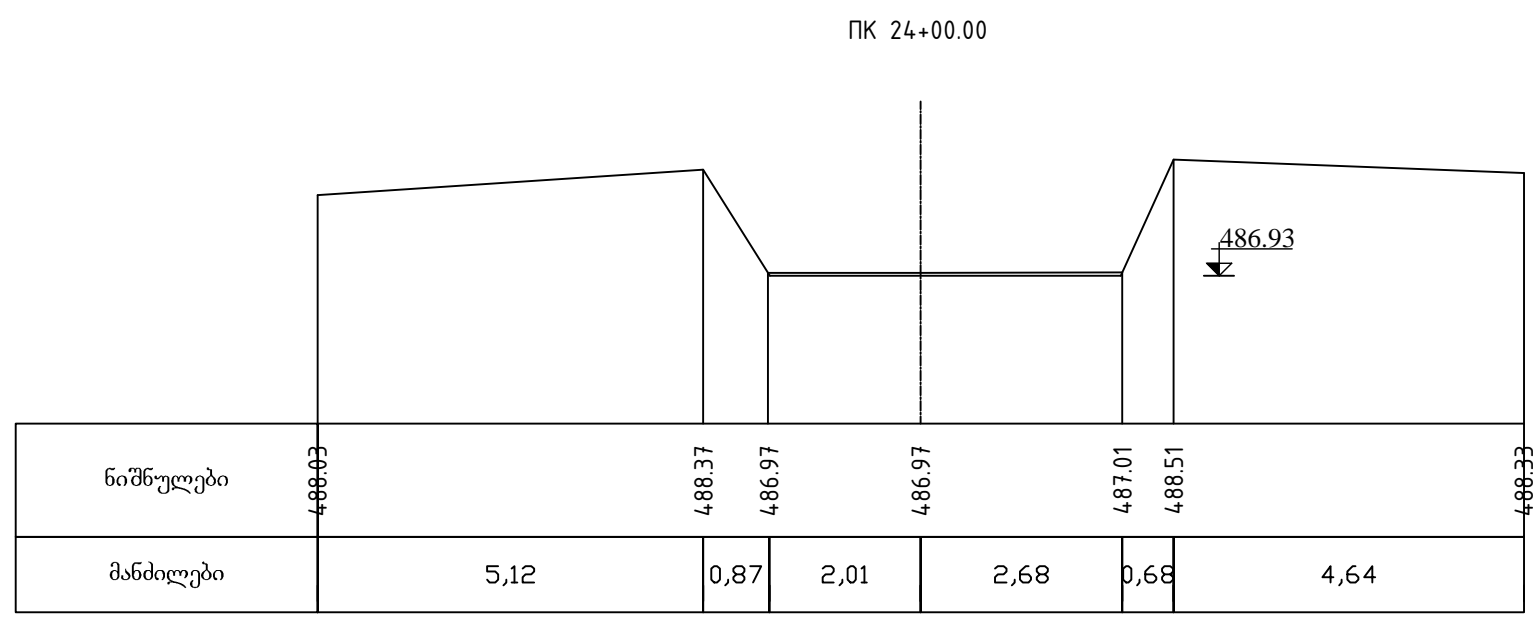
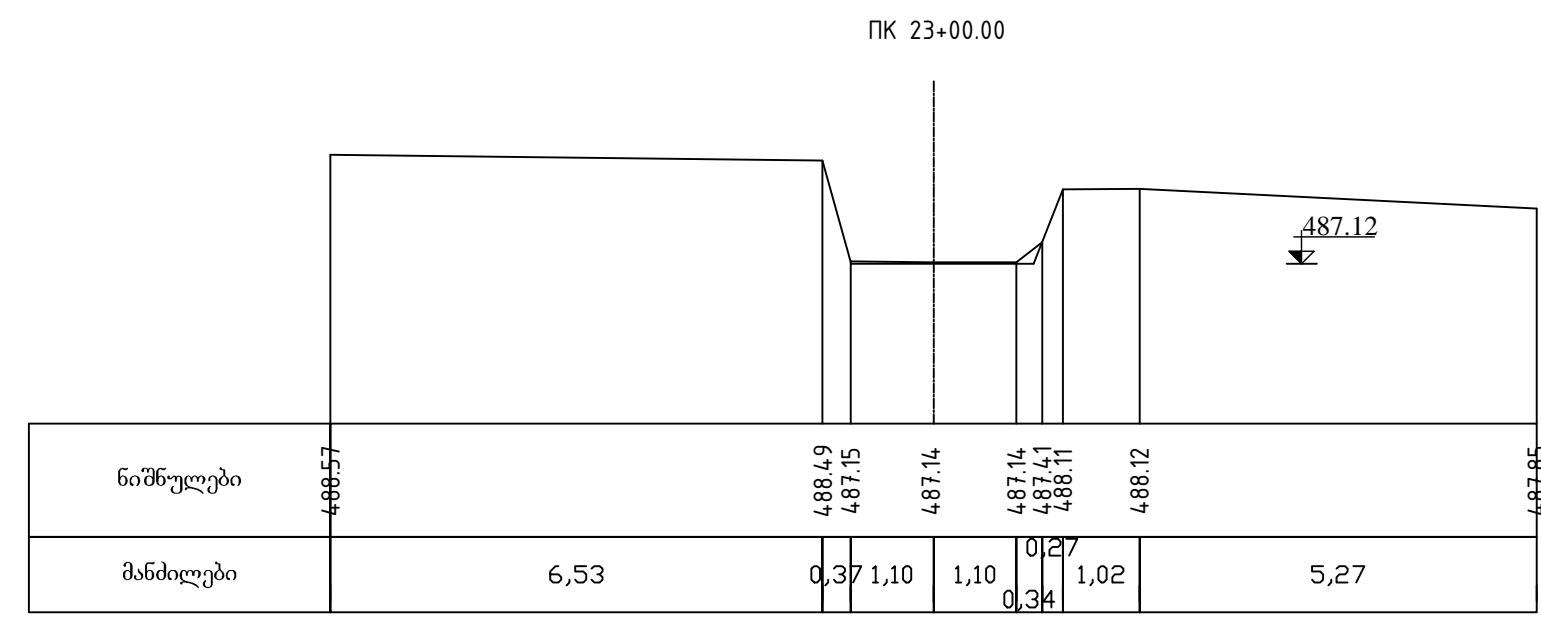
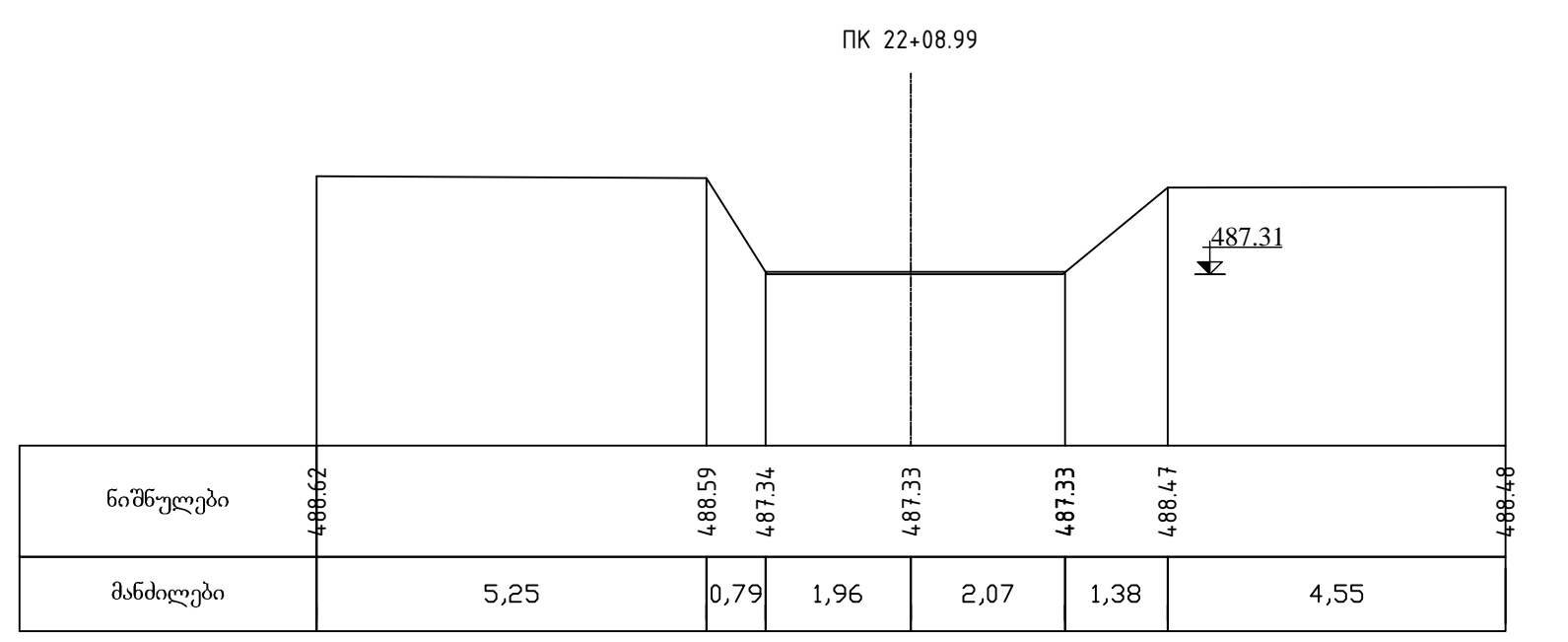
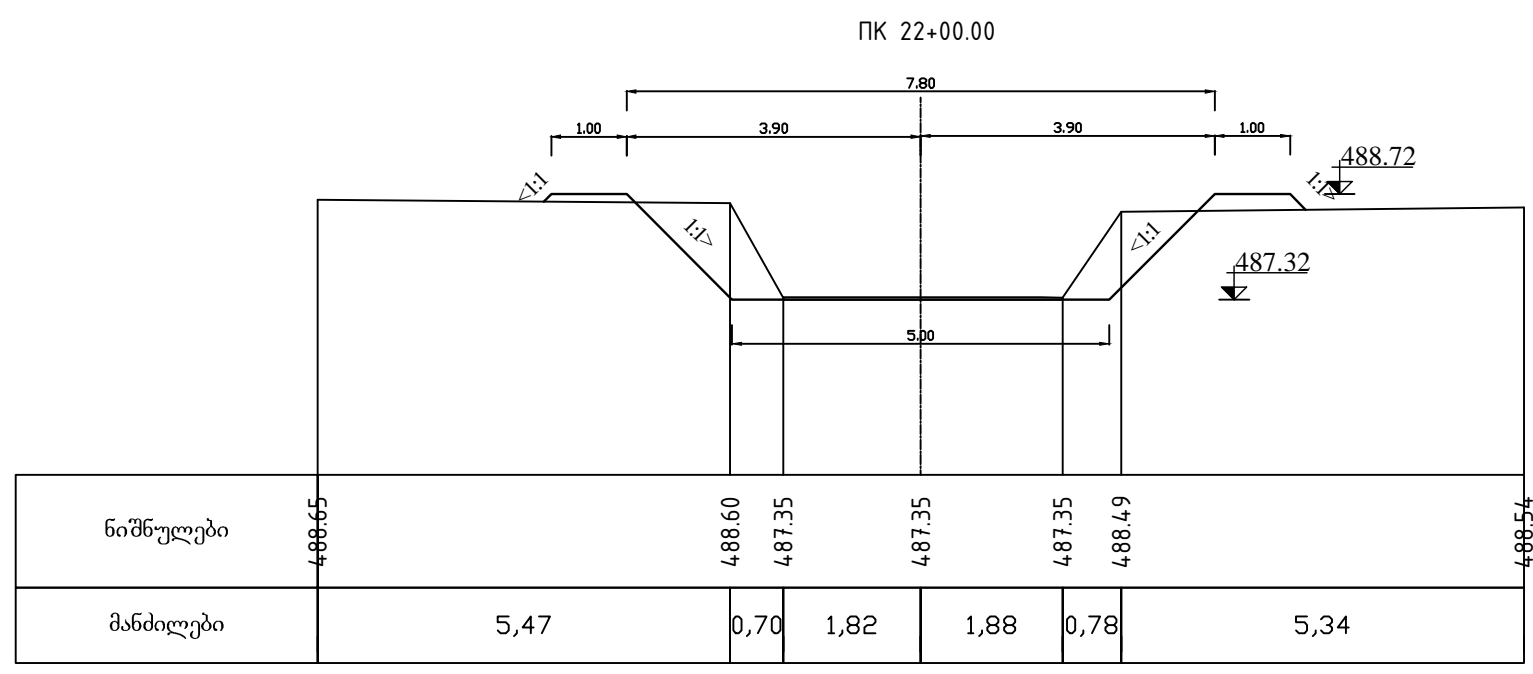
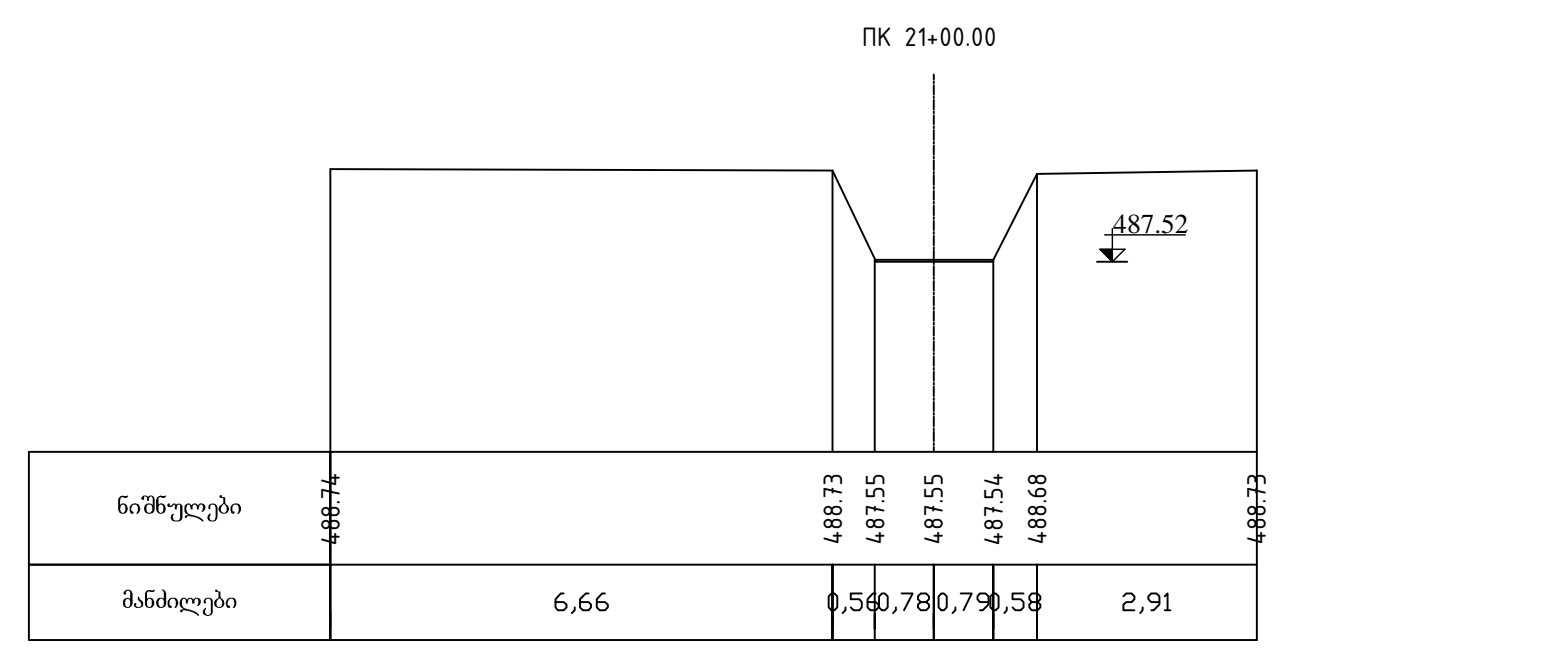
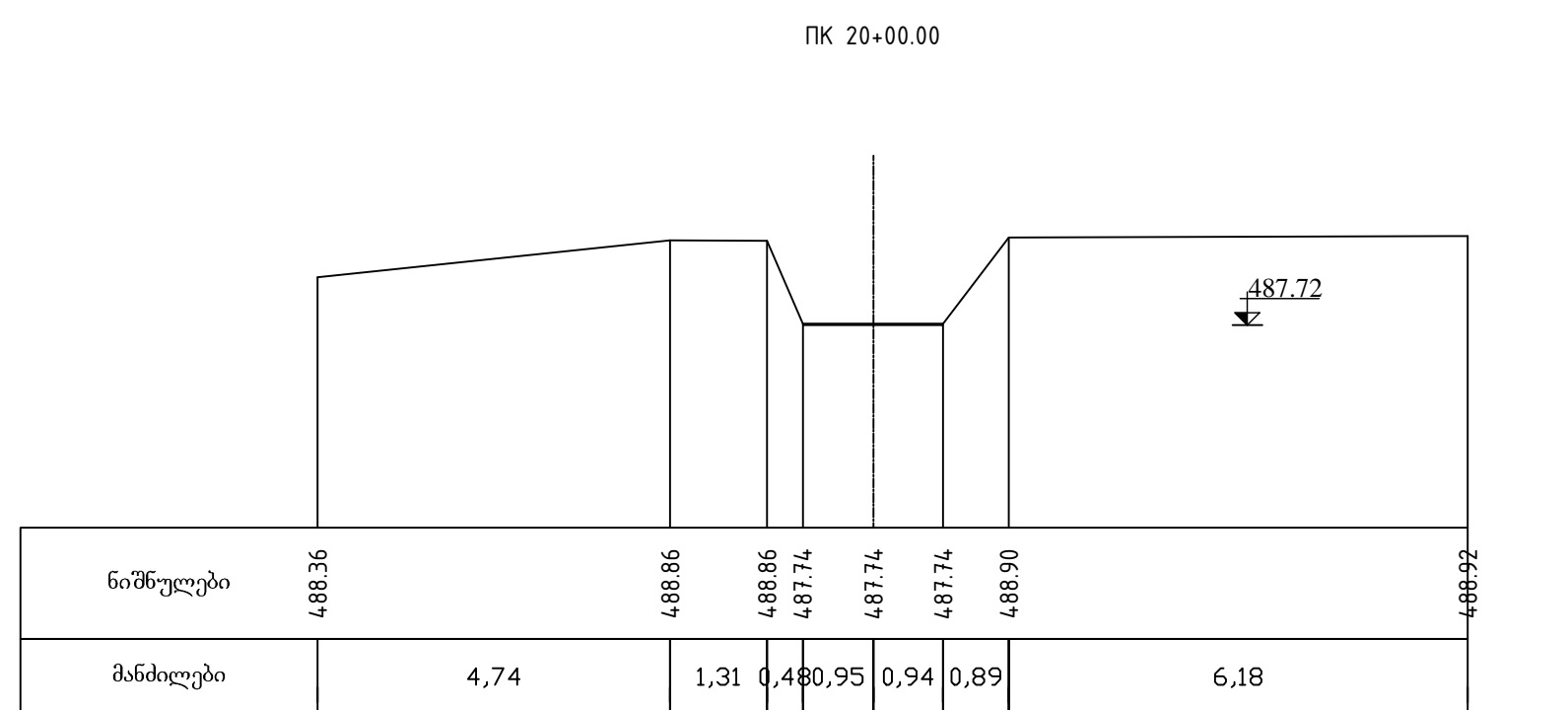
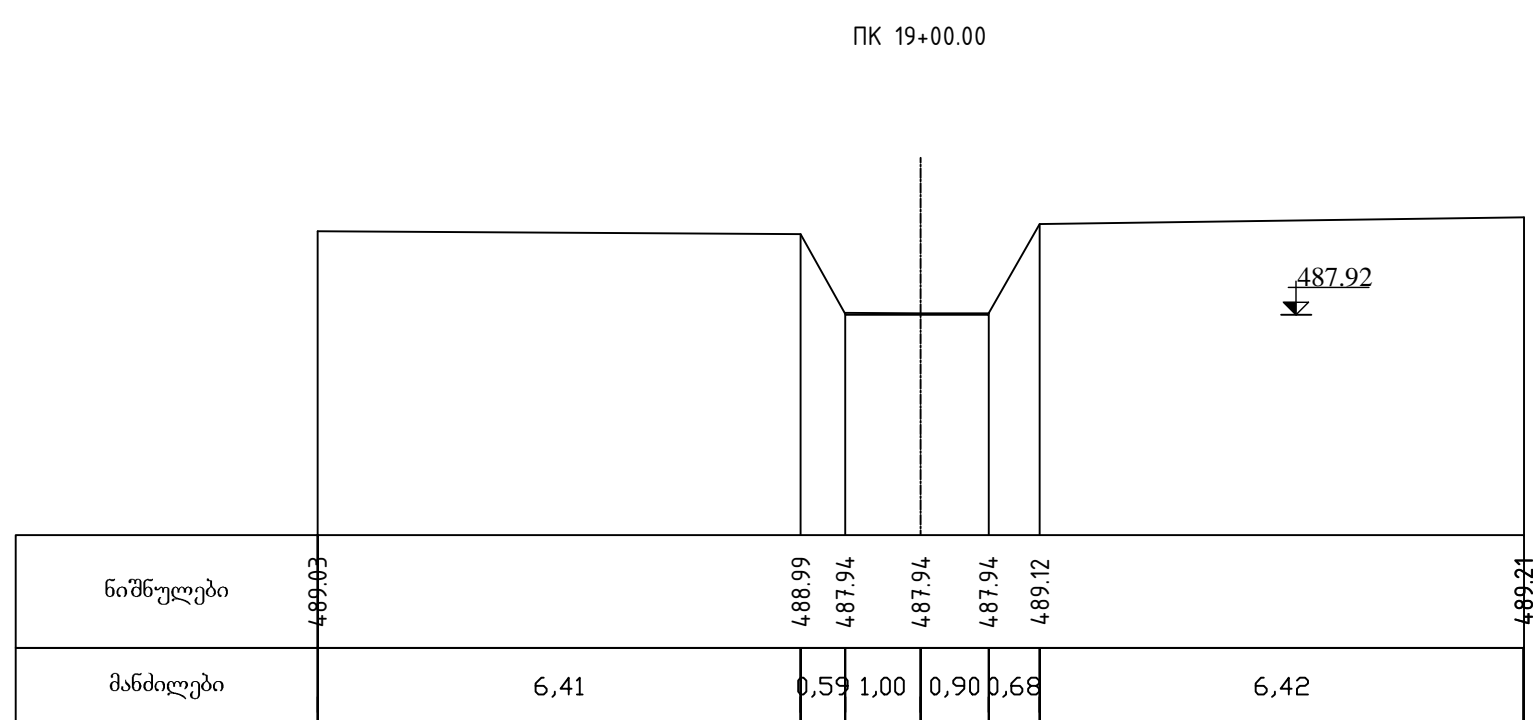
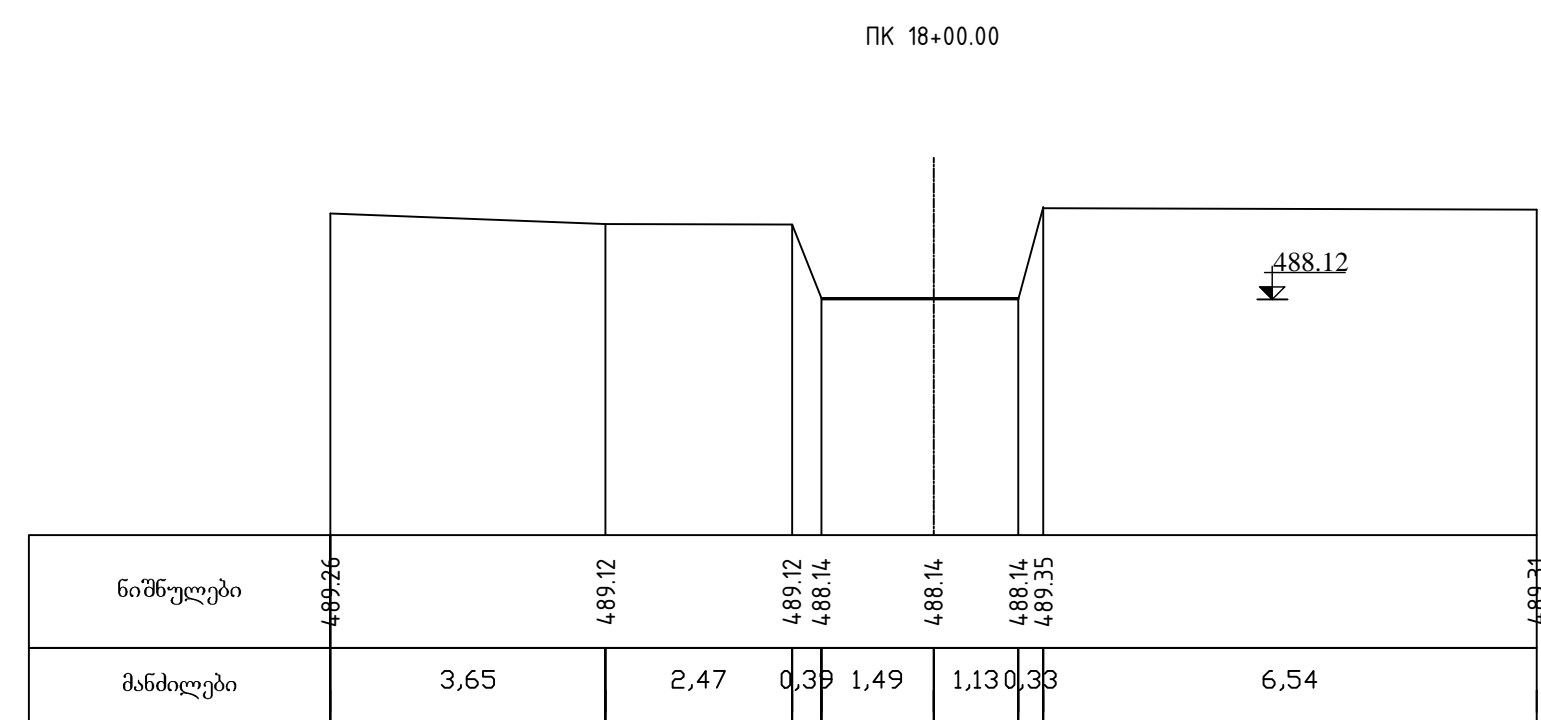
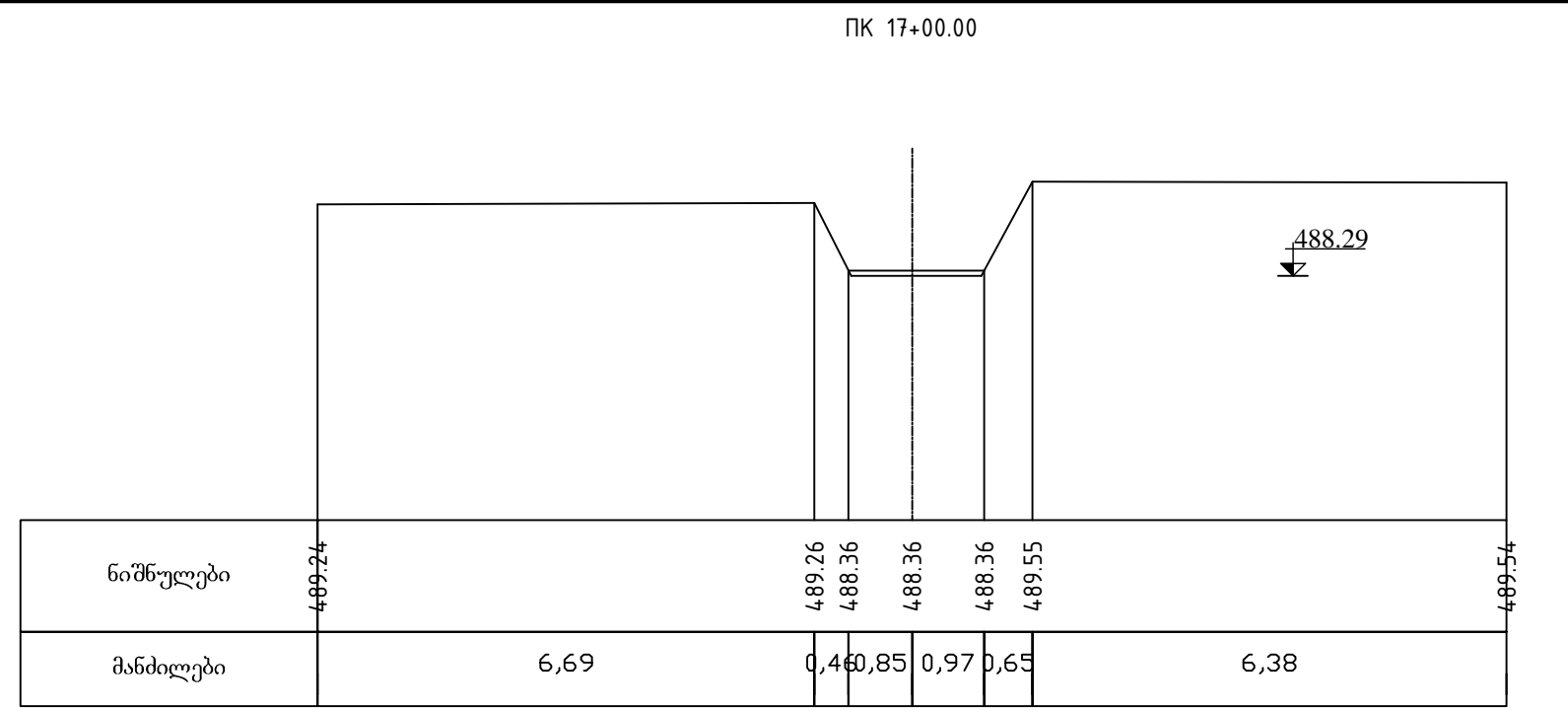
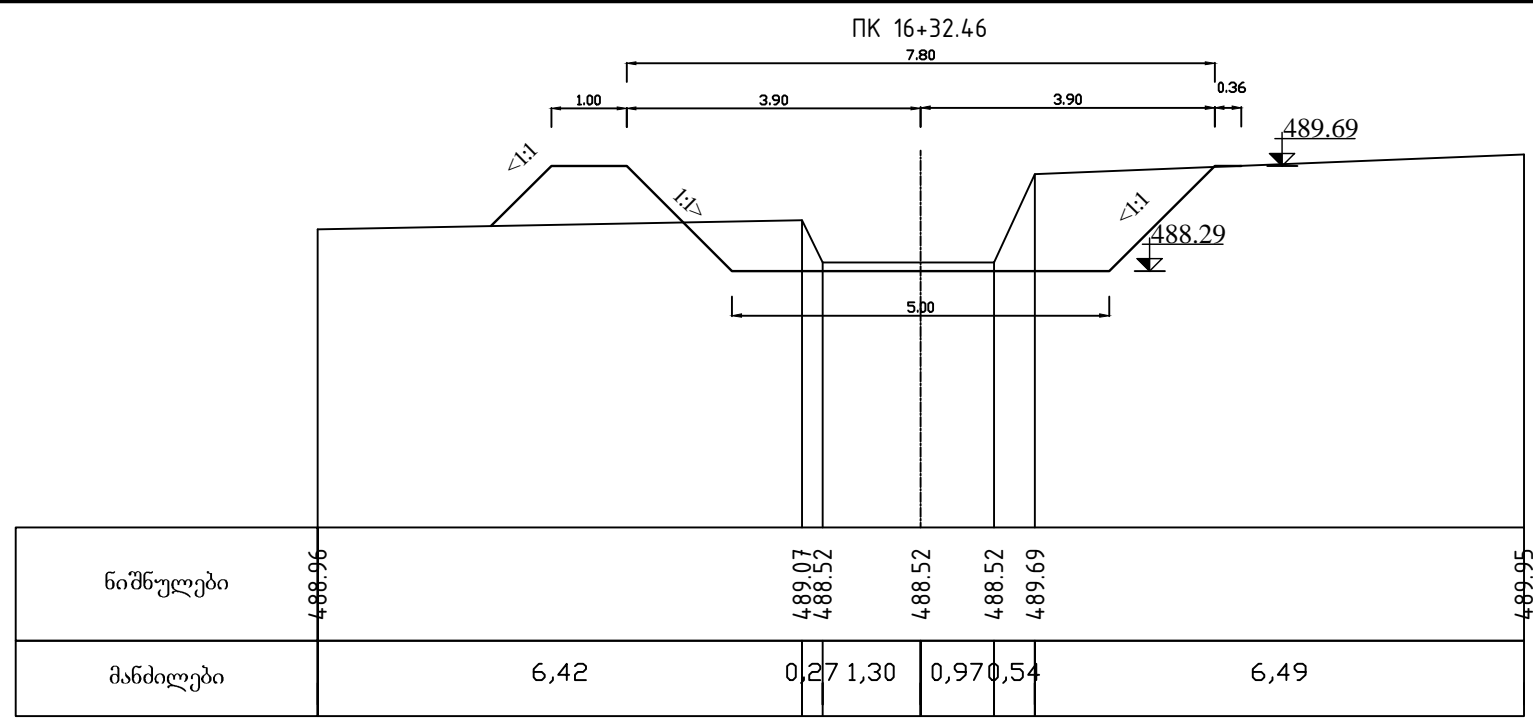
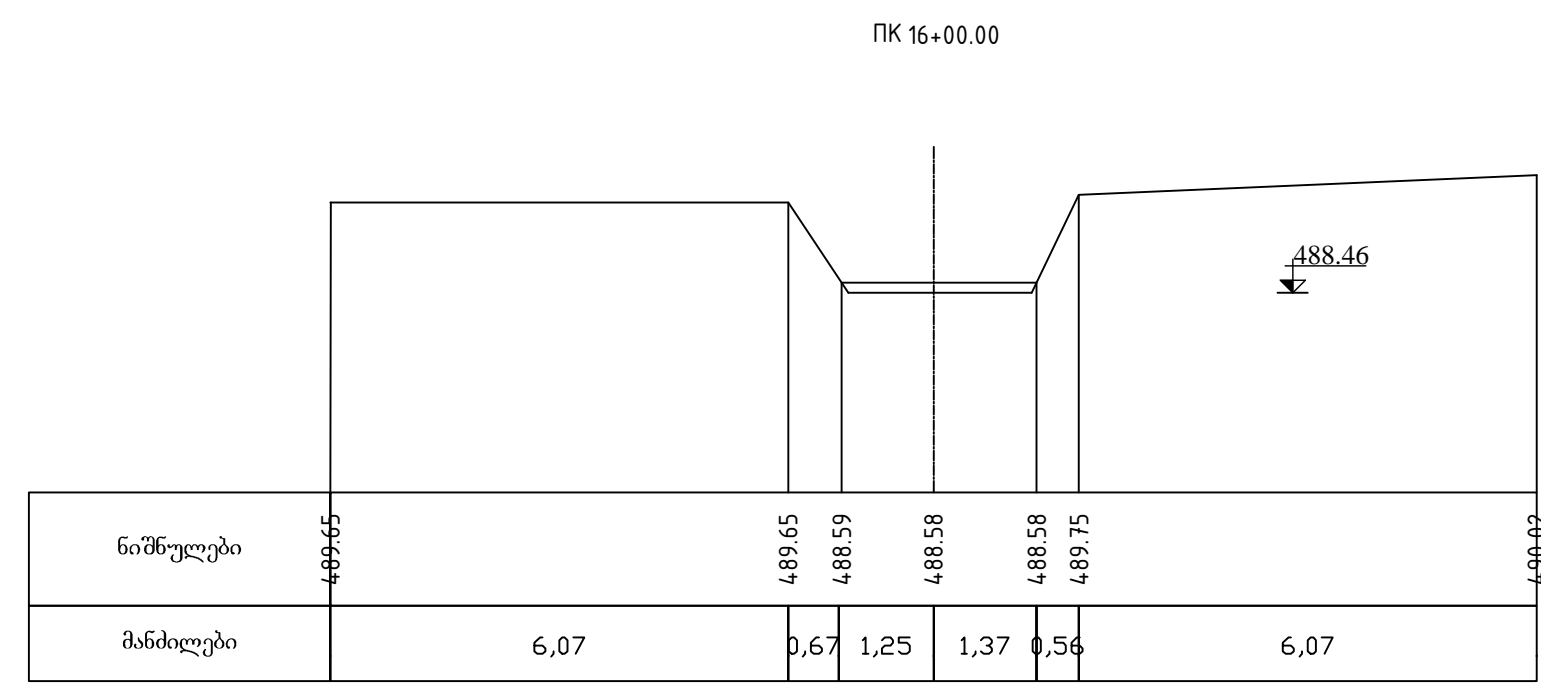

ლაშქვა							26-ბ-13 ღებულის სარეგისტრაციო ნახატი			
გეგმავი										
კონსტრუქტორი										
შემამუშავებელი										
დირექტორი										
დამამუშავებელი										
							ელვარის არხი	სტადია მ.პ.	ფურც. 2	ფურცლები 3
							განთავსებული			

